

PDC-W210

21.5" Medical-Grade LCD Monitor



Features

- Wide 21" screen with Full HD 1920 x 1080 resolution
- Professional LCD quality with 2.3 Megapixel color image
- DICOM Pre-setting and convenient for switching between DICOM and Gamma 2.2
- Support USB hub function and AC internal power supply
- Medical grade, IP-54-rated and cleanable
- PCAP Touchscreen (optional)



Specifications

Display	Display Type	21.5" wide TFT color LCD (16:9)
	Type	IPS
	Max. Resolution	1920 x 1080
	Max. Colors	16.7 M colors (6-bits+A-FRC)
	Pixel Pitch (um)	247.5 x 247.5
	Contrast Ratio	1000:1 (Typ.)
	Luminance	250 cd/m ² (Typ.)
	Viewing Angle (H/V)	178/178°
	Response Time	25ms (Typ., on/off)
	Backlight	LED
LCD MTBF	30,000 Hours	
I/O Ports	HDMI	1
	DP	1
	DVI	1
	VGA	1
	USB (Type B)	1 (optional, for P-cap touch only)
	Audio out	1
	Line in	1
Speaker	Left/ Right	
Optional Functions	DICOM	Compatible to DICOM Part 14 (optional)
Optional Touch Screen	Type	Projected Capacitive 2-points (AR)
	Resolution	Continuous
	Light transmission	90±3%
	Controller	USB interface
	Durability	Over 50 million touches
Power	Power Adapter	Input: 100 ~ 250 V _{AC} , 0.6 A, 60/50 Hz universal Output: 12 V, 5 A
	Power Consumption	<30W
Environment	Temperature	0 ~ 40° C (Operating)
	Humidity	10 ~ 95% @ 40° C (non-condensing)
	Vibration /Shock Resistance	5 ~ 500 Hz, 1G acceleration / 30G half sine, 11 ms duration
	Water/dust Resistance	IP54 for whole system
Physical Characteristics	Dimensions (W x H x D)	550 x 360 x 63.66 mm (22.95" x 15.19" x 2.51")
	Weight	5.5 Kg
	Mounting	VESA 100 x 100 mm/75 x 75 mm
Certifications		FCC Class B, CE, EN60601-1/IEC60601-1 Compliance

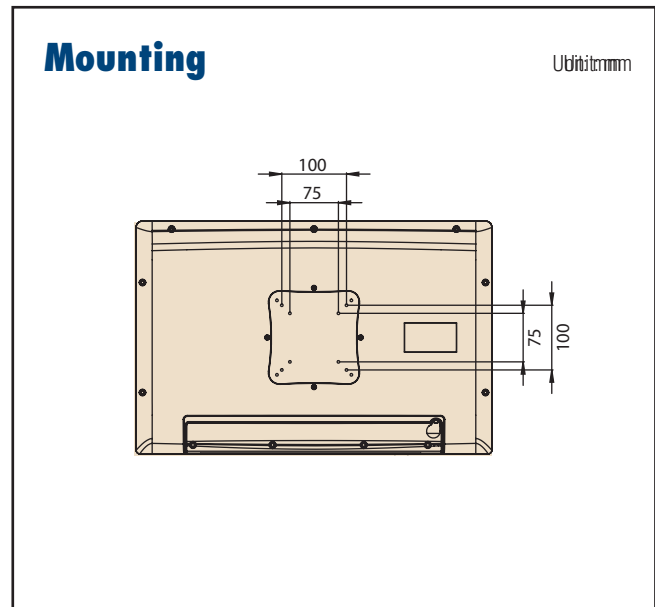
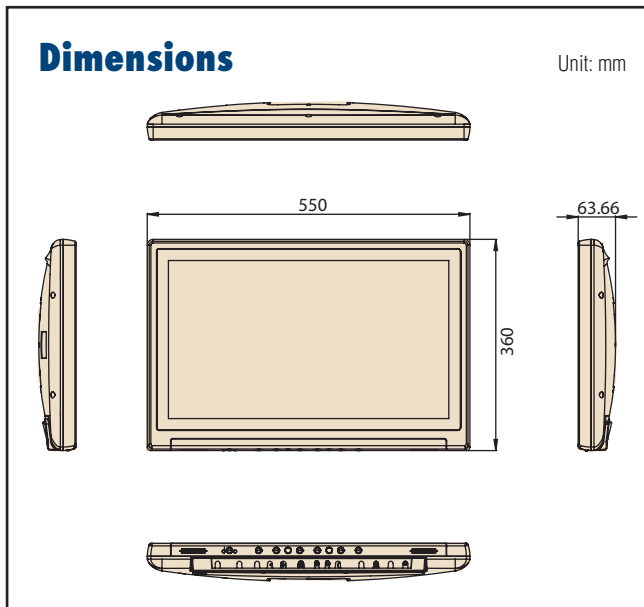

Order Information

Part Number	Touch Panel	Power
PDC-W210-D10-ATE	P-cap	Power adapter
PDC-W210-D10-AGE	X	Power adapter

Accessories

Part Number	Description
1700001524	Power Cable (USA) 1.8 M
170203183C-01	Power Cable (Europe) 1.8M
170203180A-01	Power Cable (UK) 1.8M

Rear I/O Ports

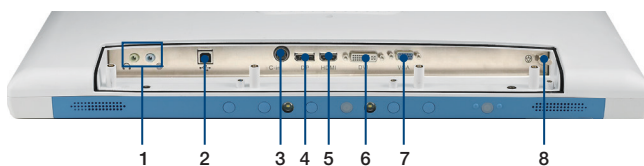

- (1) Audio: Earphone/ Audio in
- (2) P-cap USB (Type B)
- (3) Power DC-IN
- (4) DP
- (5) HDMI
- (6) DVI (cable plug should under 46mm if you use IP54 cover)
- (7) VGA
- (8) Equipotential Terminal Pin

Function Keys

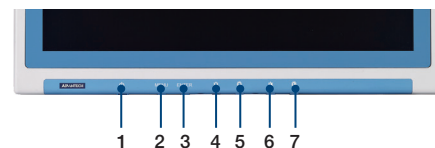

- (1) Power
- (2) Menu
- (3) Enter
- (4) Brightness Down
- (5) Brightness Up
- (6) Contrast Down
- (7) Contrast Up